



Streamline

INSTALLATION INSTRUCTIONS

VANITY TOP

SUGGESTED TOOLS

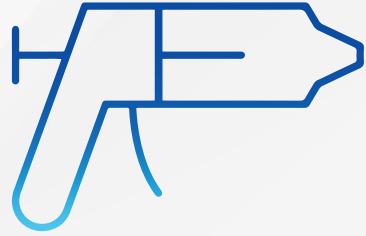

SILICONE SEALANT

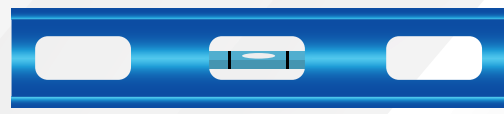

LEVEL

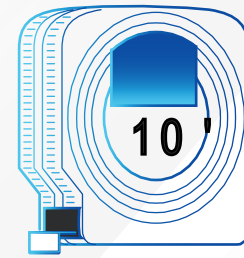

TAPE MEASURE



SAFETY GLASSES



WARNING! Even though our solid surface resin materials are durable, when handled incorrectly, it can become fragile. In order to ensure proper handling and usage, below are some tips!

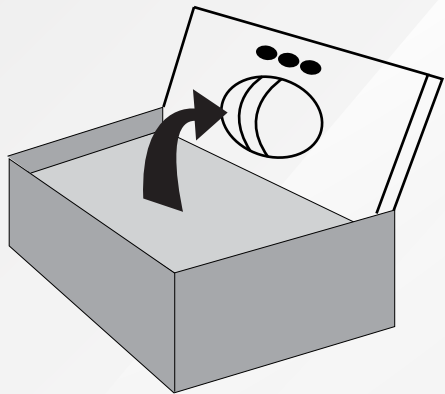

Remove the vanity from the box vertically.

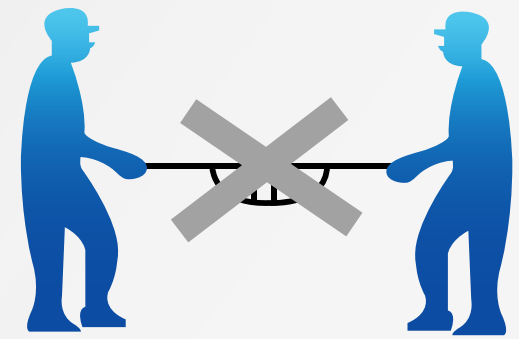
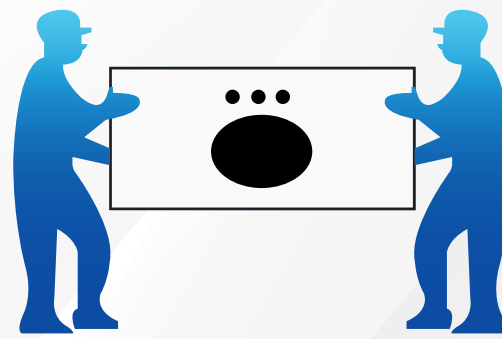

Carry the vanity top in an upright position. NEVER carry it flat. Ensure that there are two people carrying the top.

PRODUCT CARE AND MAINTENANCE



In order to clean the vanity top, please only use soft cotton cloth or soft sponge.



Never use acidic, alkali, or any products that state on their label that they're not suitable for using on poly-marble or natural stone, to clean the vanity top.



To clean the vanity top, wet the surface of the top, apply cleaning product with cloth or sponge and then use water to clean and rinse. Ensure that no cleaning products are left over on the top as it may leave residue.

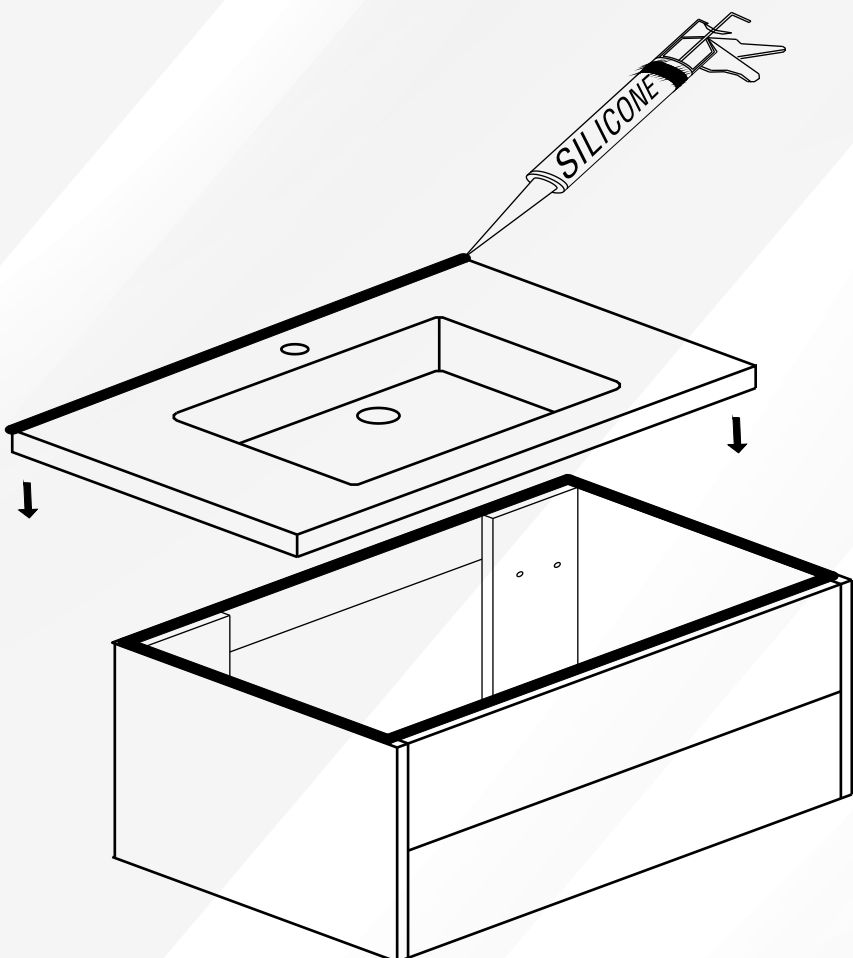

1

Carefully remove the vanity top from the box, making sure to gently place it on an even surface. At this point, it would be best to install the faucet and drain as per the manufacturer's instructions.

2

Apply silicone to the top of the cabinet. Make sure to use enough so as to ensure that the vanity will firmly stay in position.

3

If there is any excess silicone, clean it off gently with a soft cotton cloth or sponge.

4

Gently pick up the vanity top and place on the top of the cabinet, as shown in the diagram.

5

Enjoy your new bathroom vanity with your Streamline® vanity top!

NOTE: Top style, shape cutout on the top vanity may vary from the picture above. Instructional purposes only.