

INSTALLATION INSTRUCTIONS

Step 1: Drill Holes in Wall for screws or screw anchors and attached Mounting plate to Wall

Determine your desired location for installation and make a mark for the location of the mounting plate and CARD-58 CAP. Remove mounting plate from backplate by loosening set screw in backplate as pictured below. Place center hole of mounting plate over mark made above. Then also make a mark for 2x CARD-58 CAP under glass 3 inches in from both ends of glass. Make 4 marks where mounting screws will be placed as shown below. Drill hole at each of the mark. (You may substitute other style mounting anchors or screws if desired). Place anchors into the holes made. Place mounting plate over holes and secure to mounting surface using screws as shown below.

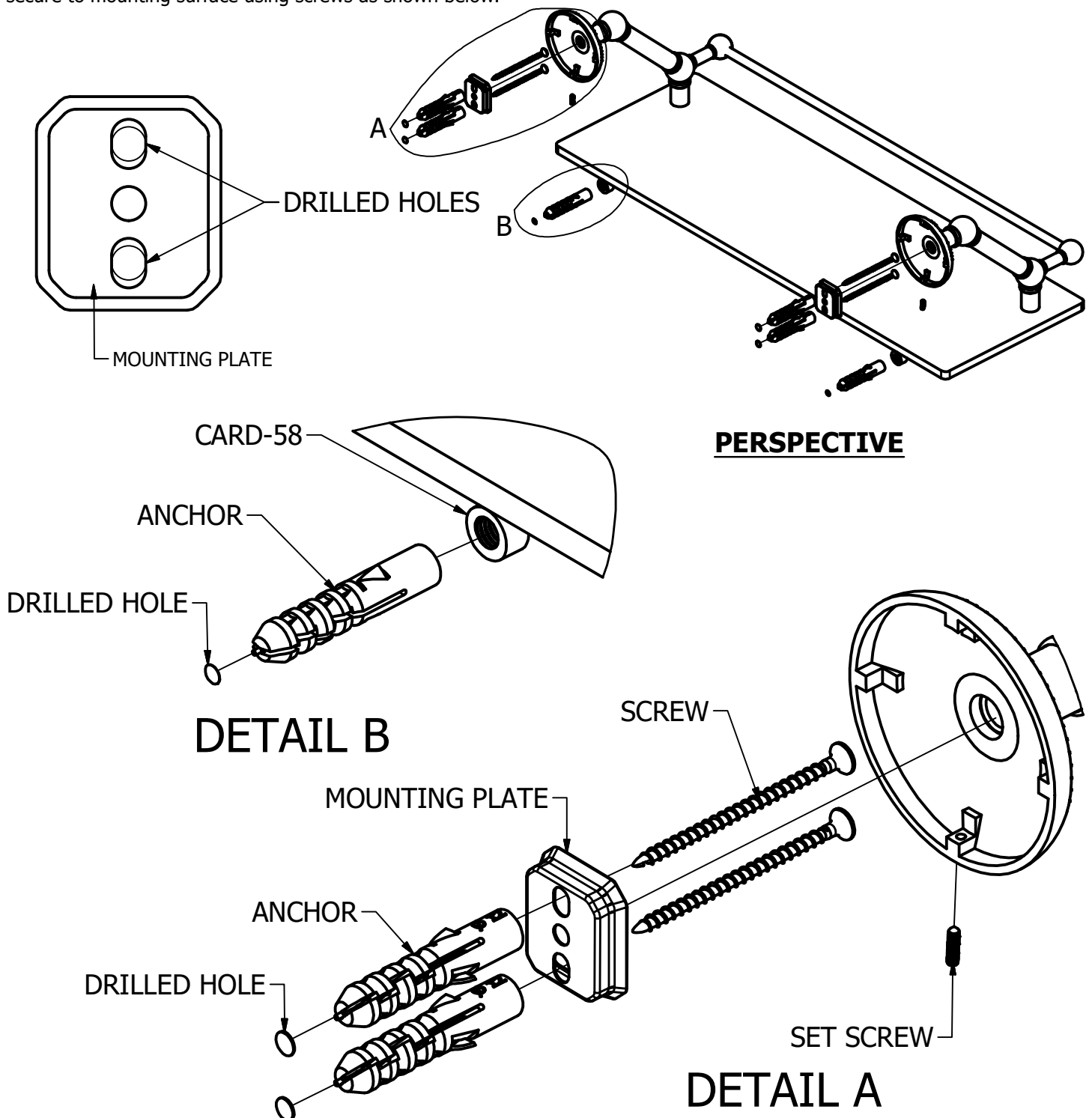

PMC-1-24-GAL



INSTALLATION INSTRUCTIONS

Step 1: Attach Bracket to Mounting Plate

Place bracket on mounting plate and secure by tightening set screw as shown below. To secure 2x CARD-58, screw the bushing on to the wall and threading on the cap for the back of the shelf to rest on.

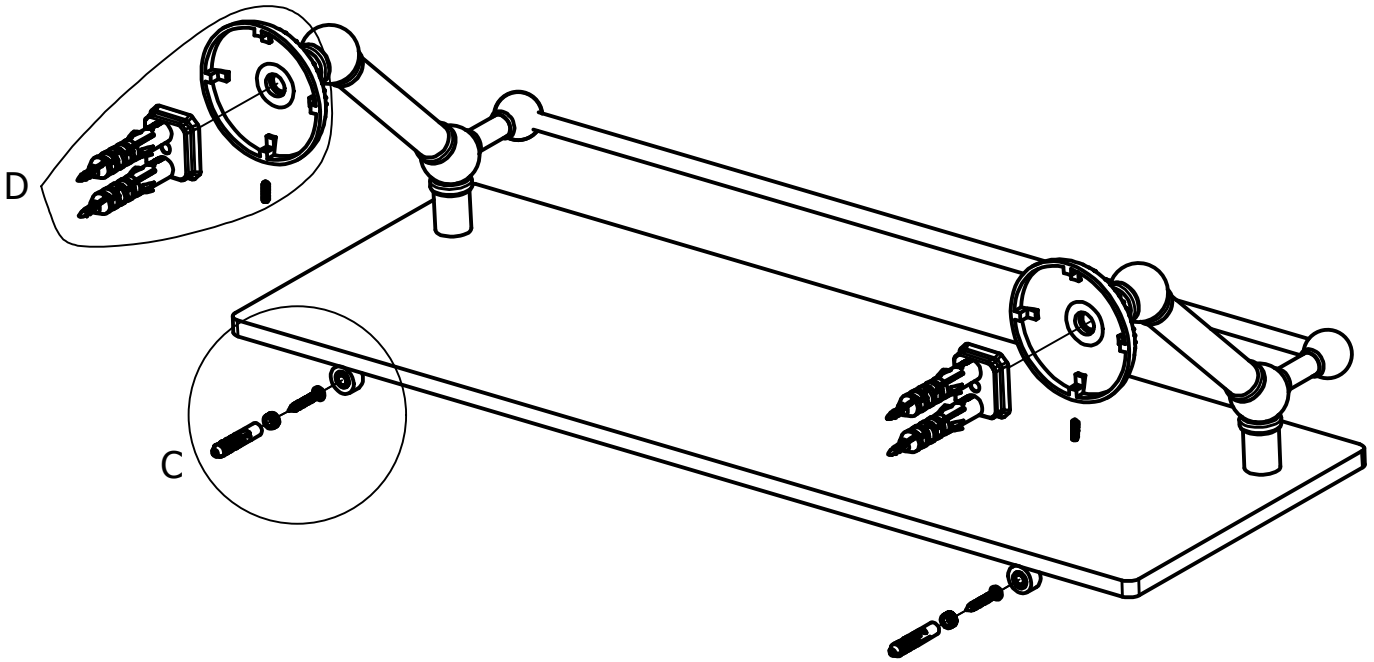

PERSPECTIVE

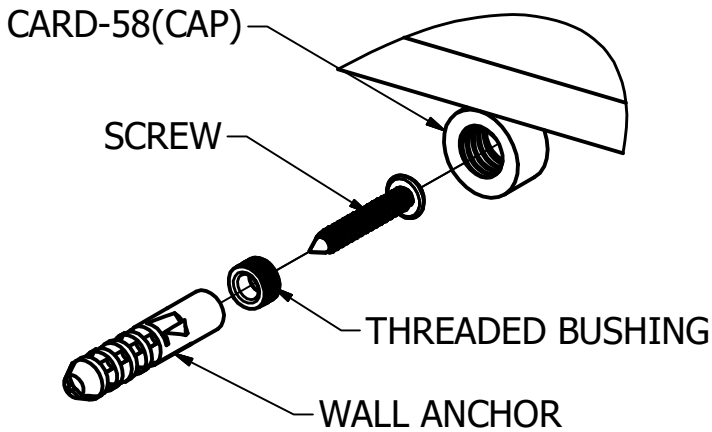

DETAIL C

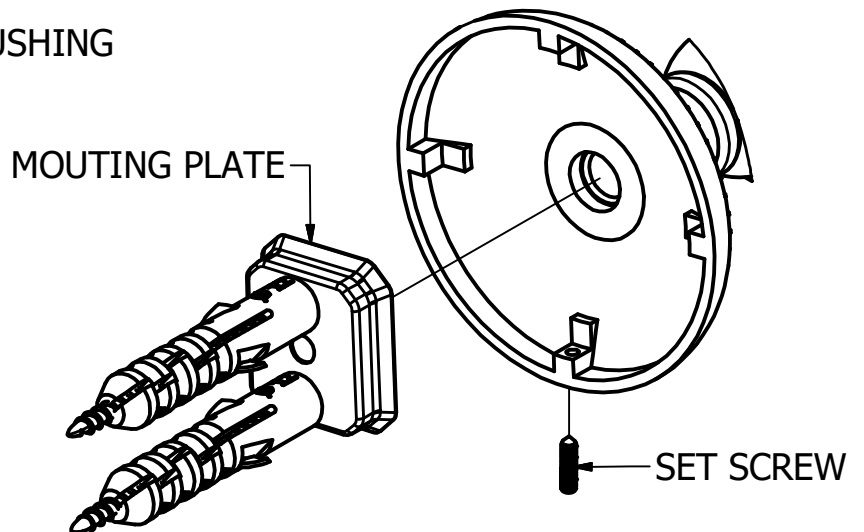

DETAIL D