

Features

- Solid polypropylene plastic.
- Round closed-front.
- Contoured seat for user comfort.
- Quick-Release™ hinge caps snap open and seat pulls forward for removal.
- Quick-Attach™ stainless steel fastener allows for top-mount screwdriver only install.



Codes/Standards







IAPMO/ANSI Z124.5

KOHLER® One-Year Limited Warranty

See website for detailed warranty information.

Available Color/Finishes

Color tiles intended for reference only.

Color	Code	Description
	0	White
	96	Biscuit
	47	Almond
	NY	Dune
	95	Ice™ Grey
	G9	Sandbar
	7	Black Black™

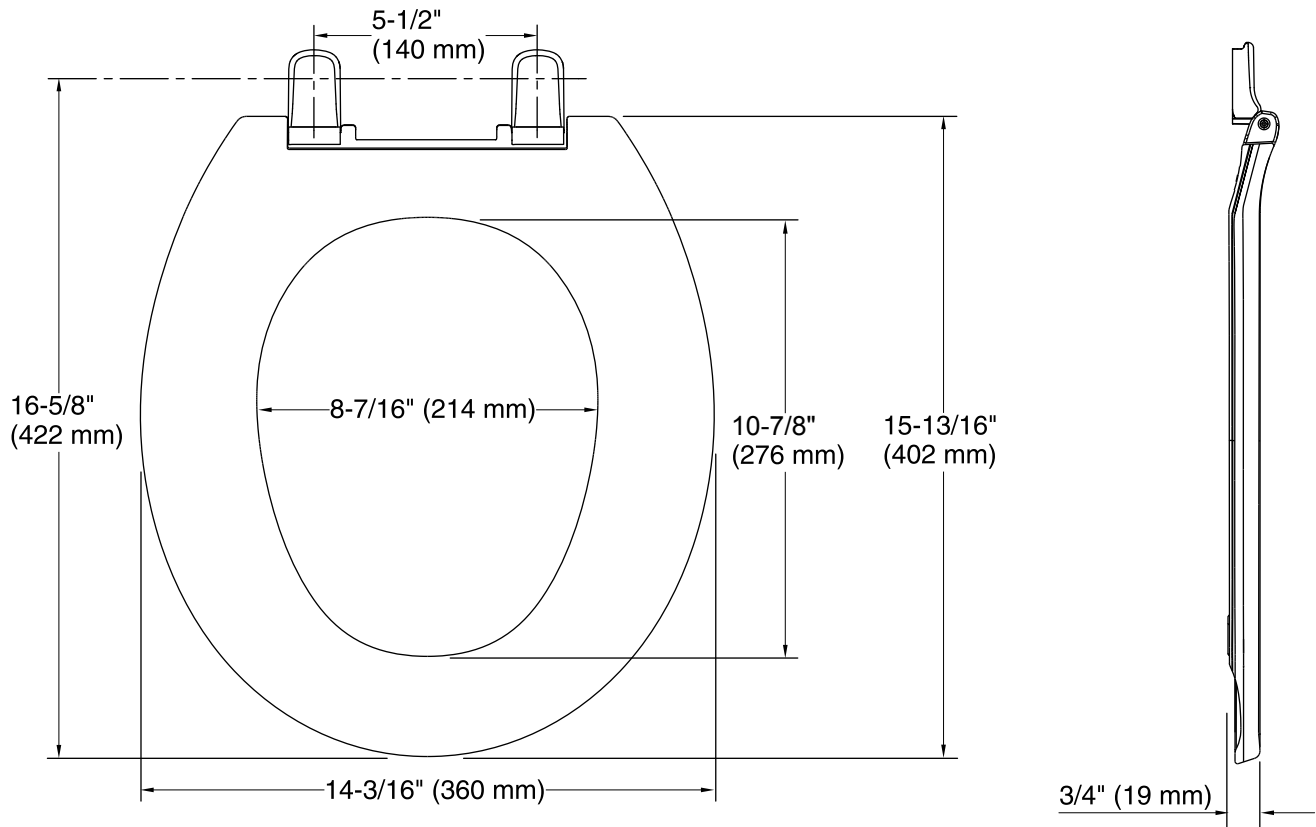

Technical Information

All product dimensions are nominal.

- Seat shape type: Round
- Seat front type: Closed front
- Seat hinge type: Quick-Attach®, Quick-Release™
- Seat-mounting holes: 5-1/2" (140 mm)

Notes

Install this product according to the installation guide.